

Part number

MAP 06 L240



Surface mounting housing, C-TYPE series, with 1 lever, M40 x 2 cable entry, size "44.27", high construction

Product description

Product type	surface mounting housing
Series	C-TYPE
Closing type	with 1 lever
Size	size "44.27"
Cable entry	M40 x 2
Specification	high construction

Technical data

IP degree of protection	IP66 (and IP69 DIN 40050 - 9)
--------------------------------	-------------------------------

Further technical details

Weight	238,00 g
Operating temperature range (min, max)	-40 °C...+125 °C

Approvals / Standards

Certifications	DNV-GL, BV
-----------------------	------------

General ordering information

EAN13 code	8015747050906
-------------------	---------------

Packaging Information

Packaging length	475,00 mm
Packaging height	200,00 mm
Packaging width	150,00 mm
Packaging weight	2,75 kg
Packaging volume	14,25 dm ³
Packaging description	Carton box
Packaging quantity	10 Pcs
Packaging EAN code	8015747239288
Sub-packaging weight	1,38 kg
Sub-packaging description	Plastic packaging
Sub-packaging quantity	5 Pcs
Sub-packaging EAN barcode	8015747050913

Part number

MAP 06 L240



Catalogue drawings

CHP L CAP L - MHP L MAP L

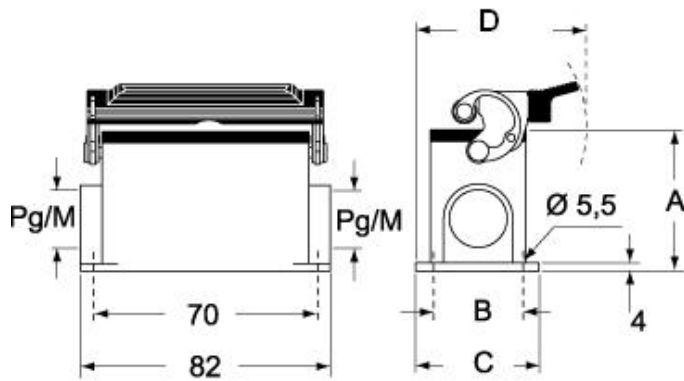

CHP LS CAP LS - MHP LS MAP LS

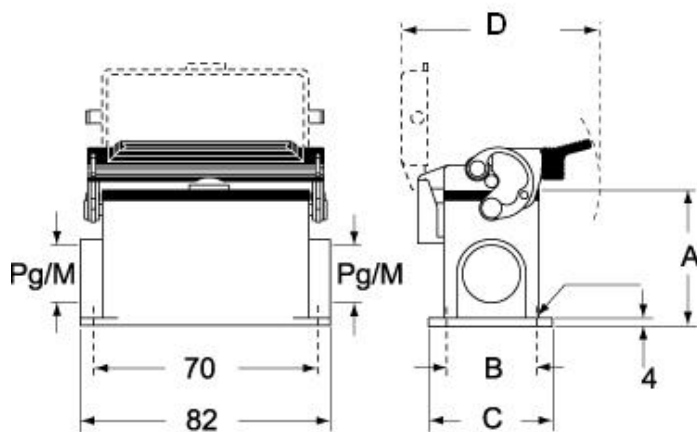

Notes

Dimensions shown in mm are not binding and may be changed without notice.