

Part number

MHP 24 L25



Surface mounting housing, C-TYPE series, with 1 lever, M25 cable entry, size "104.27"

Product description

Product type	surface mounting housing
Series	C-TYPE
Closing type	with 1 lever
Size	size "104.27"
Cable entry	M25

Technical data

IP degree of protection	IP66 (and IP69 DIN 40050 - 9)
--------------------------------	-------------------------------

Further technical details

Weight	3,80 g
Operating temperature range (min, max)	-40 °C...+125 °C

Approvals / Standards

Certifications	DNV-GL, BV
-----------------------	------------

General ordering information

EAN13 code	8015747054768
-------------------	---------------

Packaging Information

Packaging length	475,00 mm
Packaging height	180,00 mm
Packaging width	200,00 mm
Packaging weight	3,80 kg
Packaging volume	17,10 dm ³
Packaging description	Carton box
Packaging quantity	10 Pcs
Packaging EAN code	8015747054775
Sub-packaging weight	1,90 kg
Sub-packaging description	Plastic packaging
Sub-packaging quantity	5 Pcs
Sub-packaging EAN barcode	8015747054782

Part number

MHP 24 L25



Catalogue drawings

CHP L CAP L - MHP L MAP L

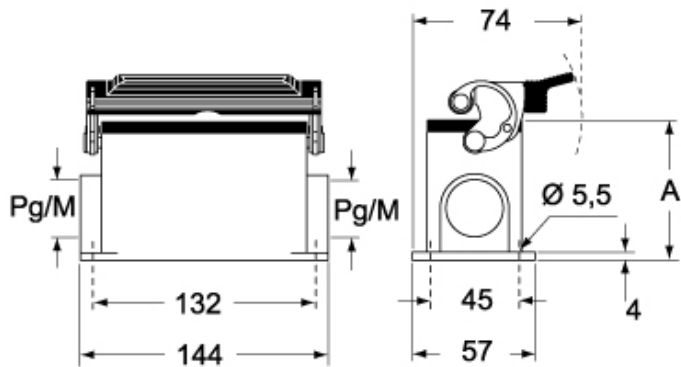

CHP LS CAP LS - MHP LS MAP LS

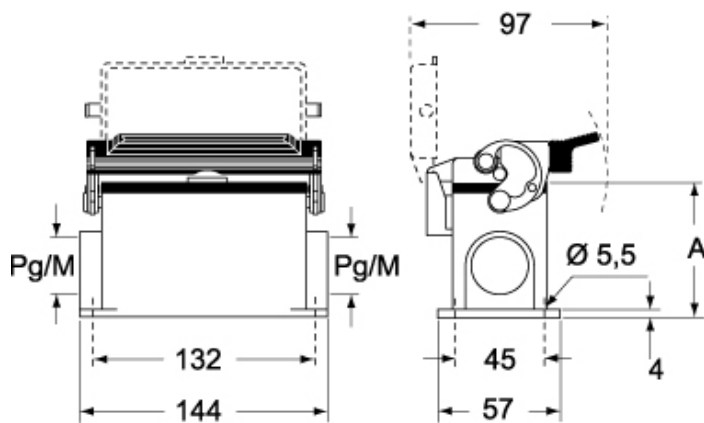

	A
CHP L / MHP L	63
CAP L / MAP L	80
CHP LS / MHP LS	63
CAP LS / MAP LS	80

Notes

Dimensions shown in mm are not binding and may be changed without notice.