

Part number

# MHP 32 L240



Surface mounting housing, C-TYPE series, with 1 lever, M40 x 2 cable entry, size "77.62"



#### Product description

<b>Product type</b>	surface mounting housing
<b>Series</b>	C-TYPE
<b>Closing type</b>	with 1 lever
<b>Size</b>	size "77.62"
<b>Cable entry</b>	M40 x 2

#### Technical data

<b>IP degree of protection</b>	IP66 (and IP69 DIN 40050 - 9)
--------------------------------	-------------------------------

#### Further technical details

<b>Weight</b>	790,00 g
<b>Operating temperature range (min, max)</b>	-40 °C...+125 °C

#### Approvals / Standards

<b>Certifications</b>	DNV-GL, BV
-----------------------	------------

#### General ordering information

<b>EAN13 code</b>	8015747054911
-------------------	---------------

#### Packaging Information

<b>Packaging length</b>	475,00 mm
<b>Packaging height</b>	200,00 mm
<b>Packaging width</b>	150,00 mm
<b>Packaging weight</b>	3,61 kg
<b>Packaging volume</b>	14,25 dm <sup>3</sup>
<b>Packaging description</b>	Carton box
<b>Packaging quantity</b>	4 Pcs
<b>Packaging EAN code</b>	8015747140966
<b>Sub-packaging length</b>	116,00 mm
<b>Sub-packaging height</b>	113,00 mm
<b>Sub-packaging width</b>	142,00 mm
<b>Sub-packaging weight</b>	0,90 kg
<b>Sub-packaging volume</b>	1,86 dm <sup>3</sup>
<b>Sub-packaging description</b>	Carton box
<b>Sub-packaging quantity</b>	1 Pcs
<b>Sub-packaging EAN barcode</b>	8015747099806

Part number

# MHP 32 L240



Catalogue drawings

## CHP L CAP L - MHP L MAP L

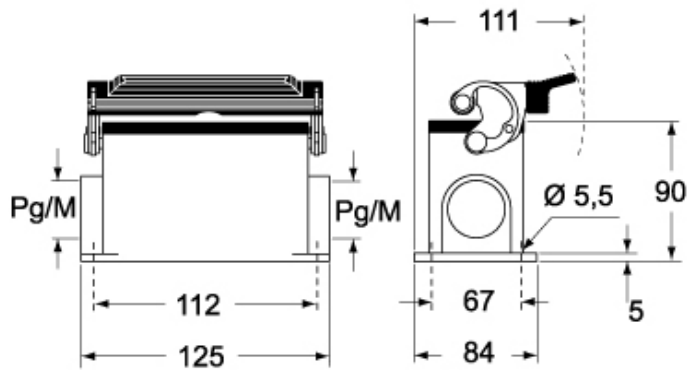

## CHP LS CAP LS - MHP LS MAP LS

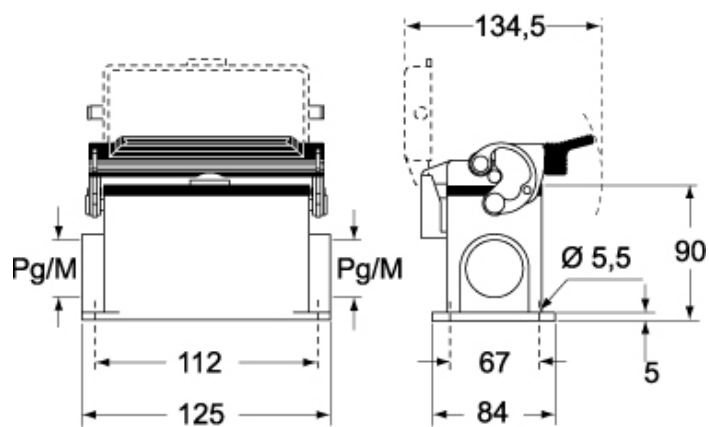

## Notes

Dimensions shown in mm are not binding and may be changed without notice.