

Part number

MFV 16 LG40



Hood, C-TYPE series, with 1 lever, M40 top cable entry without adapter, size "77.27", high construction

Product description

Product type	Hood
Series	C-TYPE
Closing type	with 1 lever
Size	size "77.27"
Cable entry	top cable entry without adapter M40
Specification	high construction

Technical data

IP degree of protection	IP65 without O-Ring gasket, IP66/IP67 with O-Ring gasket
--------------------------------	--

Further technical details

Operating temperature range (min, max)	-40 °C...+125 °C
---	------------------

Approvals / Standards

Certifications	DNV-GL, BV
-----------------------	------------

General ordering information

EAN13 code	8015747080897
-------------------	---------------

Packaging Information

Sub-packaging description	Plastic packaging
----------------------------------	-------------------

Sub-packaging quantity	5 Pcs
-------------------------------	-------

Sub-packaging EAN barcode	8015747080903
----------------------------------	---------------

Part number

MFV 16 LG40



Catalogue drawings

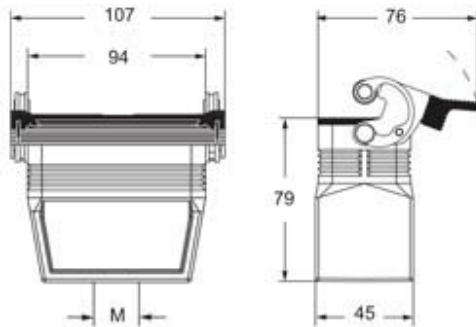

Notes

Dimensions shown in mm are not binding and may be changed without notice.
