

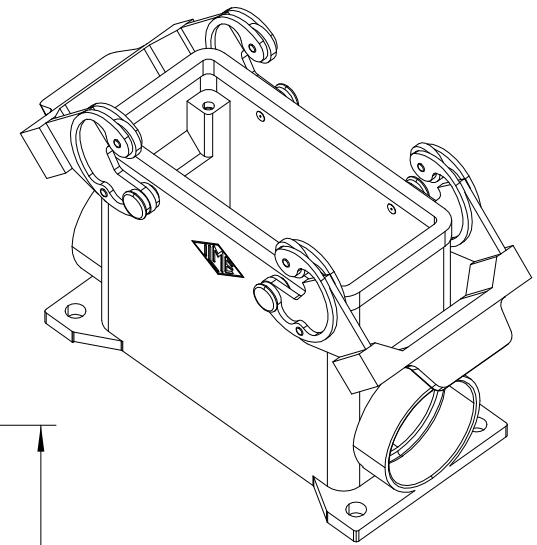

Diritti riservati All rights reserved

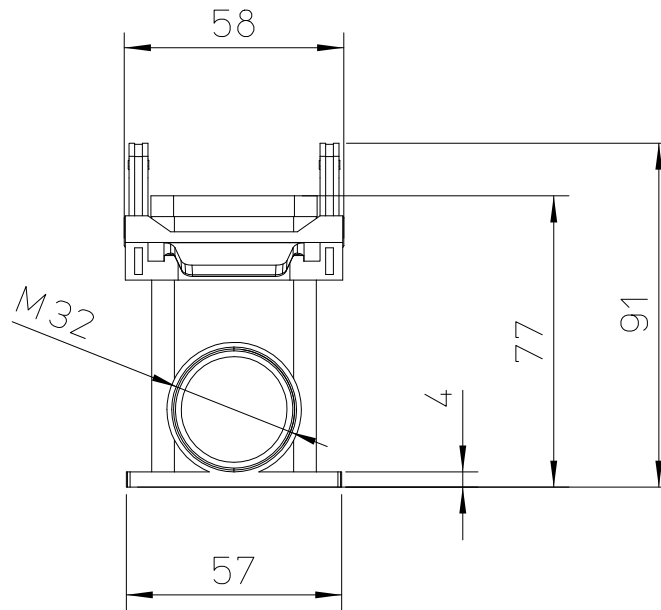
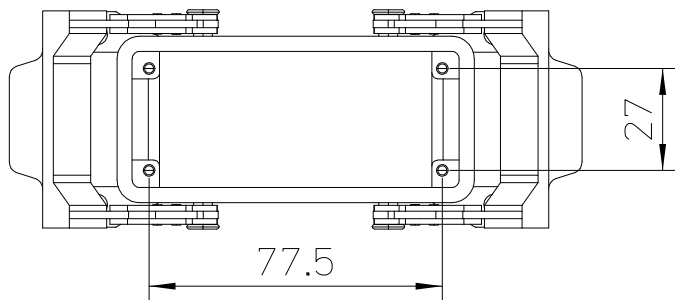
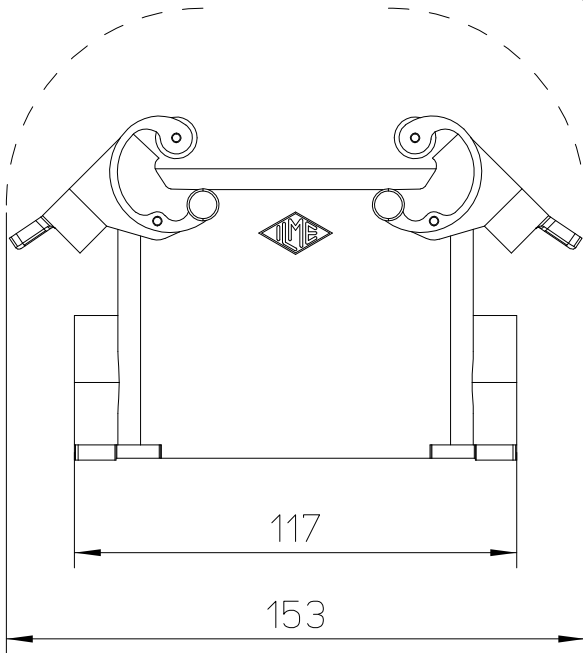
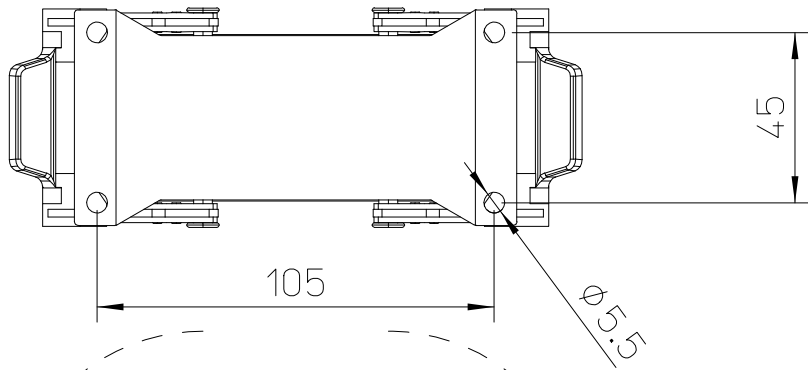

dimensions in mm		<b>MAPE 16.32</b> Surface mounting housing h. , M32, 2 levers - E-Xtreme	Scale 1:2	
Date	10/03/17			
Sign.	C. Mainini			